

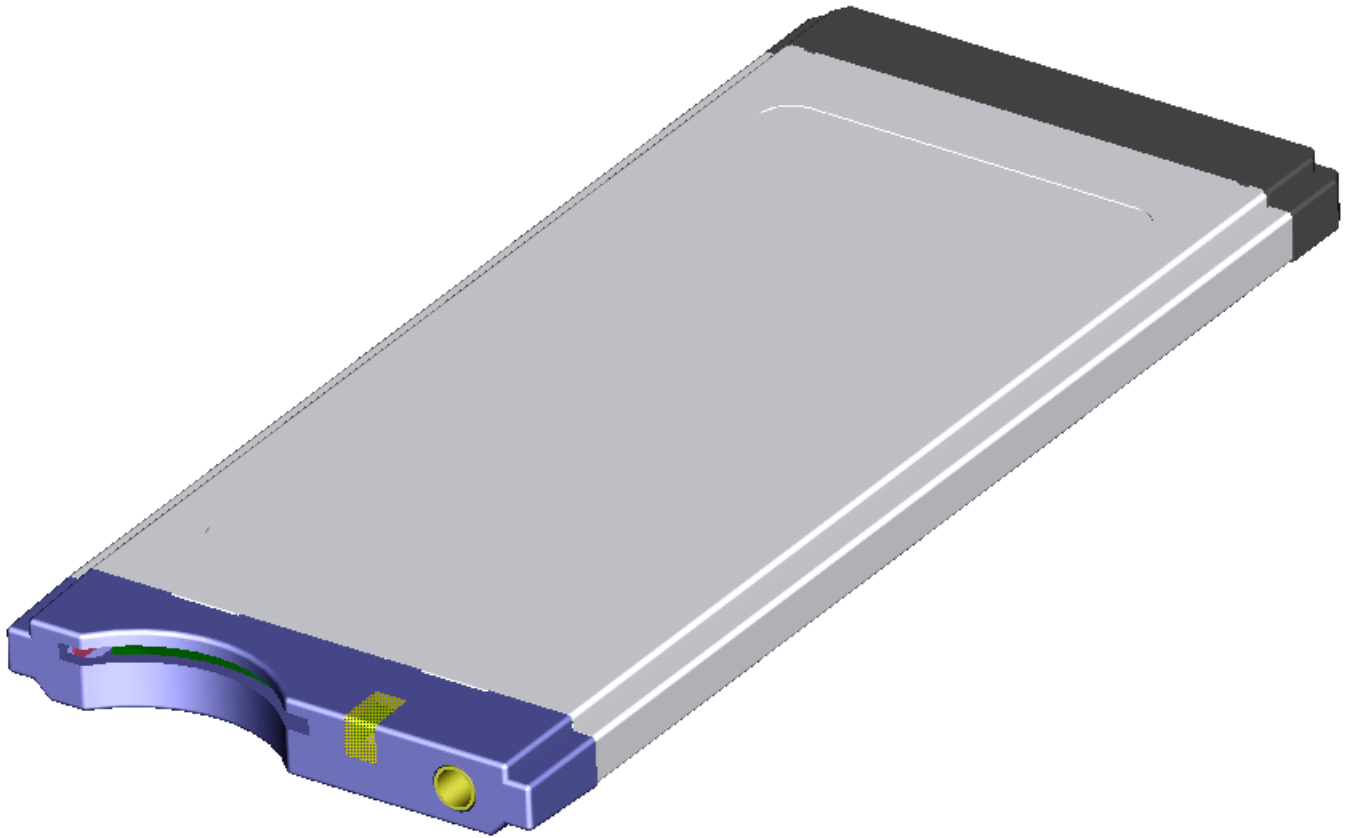

Approval Sheet



Customer : _____

Description : Express Card Into CDMA

Project No. : _____

Customer No. : _____

BroadTek No. : E-211-007-111

Date. : 2006,9,30

BroadTek Technology Co., Ltd.

Tel :886-2-29642625 Fax: 886-2-29642601

4F.,No.15,Lane 163,Sinyi Rd .,Banciao City,Taipei County 220,Taiwan

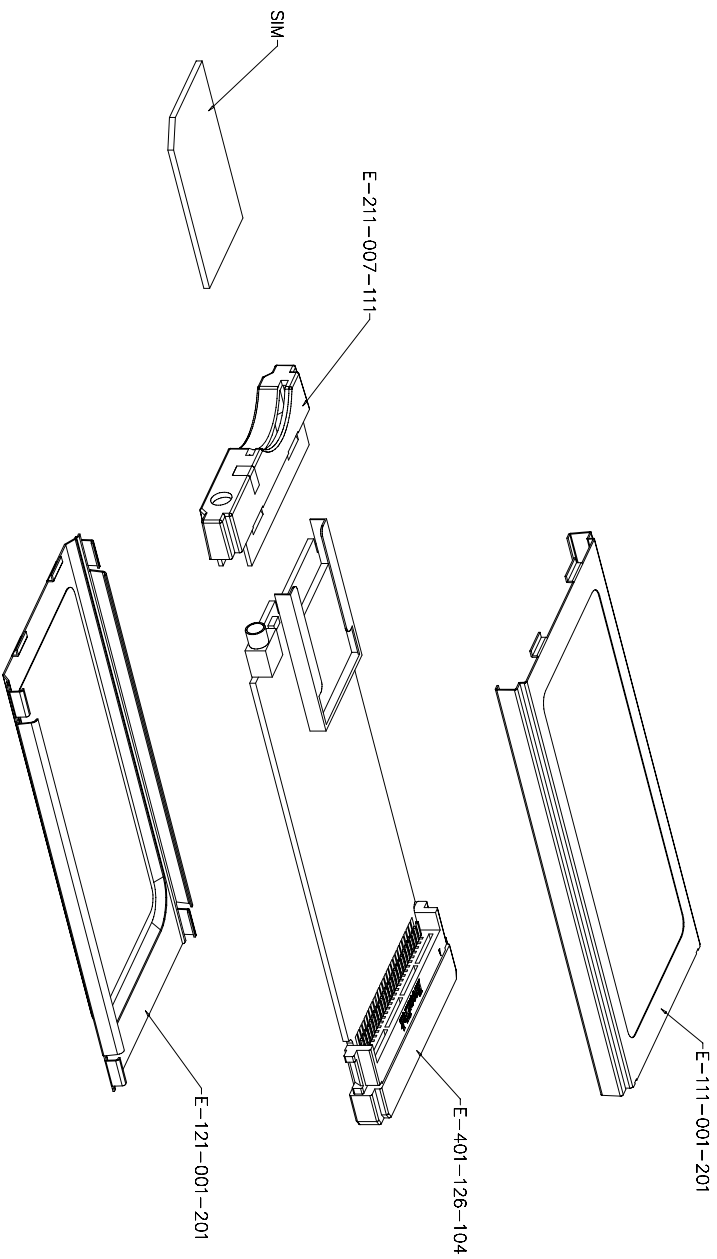

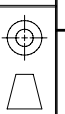
— Tolerances — Unless Otherwise Specified		Approved:		Checked:		Title : Exploding view for component	
.0	±0.15			Drawing NO. E-211-007-111-EXP		Part NO.	
.00	±0.10						
.000	±0.05	Engineer:		Drawn:		Unit: mm	Scale: 1:1
ANGLES ±1°							Size A4
						Rev. 01	Sheet 01

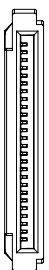
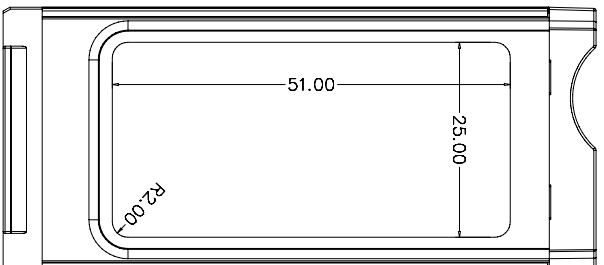
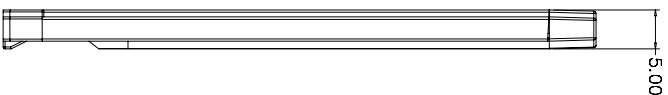
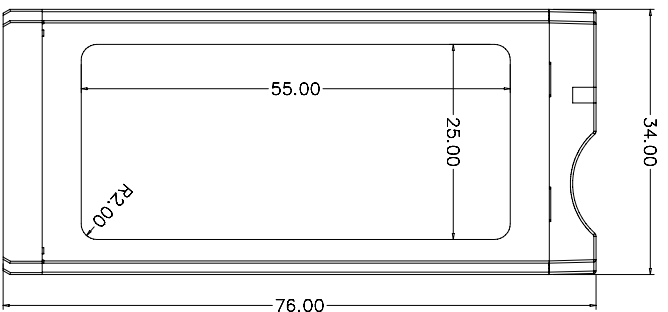
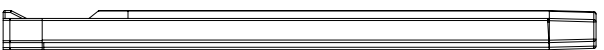
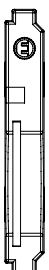

— Tolerances —
Unless Otherwise Specified

.0	±0.15
.00	±0.10
.000	±0.05
ANGLES	±1°



Approved: _____
Checked: _____

Engineer: _____
Drawn: _____

Title : Assembly

Drawing NO. E-211-007-111-ALL

Part NO.

Unit: mm	Scale: 1:1	Size: A4	Rev. Sheet: 01
----------	------------	----------	----------------